

Indoor Localization of Mobile Robots Using Active LED Beacons

Bojana Gajić, Nemanja Janković, Slobodan Koprivica, Nenad Jovičić

Department of Electronics
University of Belgrade,
School of Electrical Engineering
Belgrade, Serbia
bojanagajic91@gmail.com

Abstract— In this paper we present concept of using active beacons and machine vision approach for indoor localization of mobile robots. The system includes several cameras placed around the planar terrain in which robots are moving, active beacons mounted on top of each robot, electronic devices with wireless communication units and computer running image processing algorithm. The basic idea lies in robust background suppression method enabled by possibility to timely control the emission intensity of LED beacons. The concept is verified by experimental results, and tested using earlier developed referent system.

Keywords - active beacons; localization; machine vision; mobile robots

I. INTRODUCTION

Mobile robots are widely used in many areas in modern society. In order to plan the next movement, every robot has to be aware of its current position. That makes the localization problem one of the crucial tasks in building a mobile robot. There are many ways to solve this problem by using different sensors, such as Laser Range Finder (LRF) [1], encoders [2], Global Positioning System (GPS) [3], ultra-sonic [4] and vision sensors [5]. In order to gain better precision and more accuracy, many approaches combine a few different methods [6]. Based on their dependency on environmental landmarks, the localization systems can also be divided into two groups. First group uses fixed beacons or landmarks distributed in known environment [7], while second group relies on sensors and equipment mounted only on robot itself [8]. Some systems can now localize in large areas such as city streets [9] and in many different indoor [10, 11], outdoor environments [12]. Motion capture (Mo-cap in short) is the process of recording the movement of objects or people. It is used in military, entertainment, sports, medical applications, and for validation of computer vision and robotics. Motion capture systems can be divided in three main groups: inside-in, inside-out and outside-in [13]. Motion capture systems are used in everyday surrounding [14] and in controlled conditions. Active LED markers are widely used for localization in many areas, so even CMOS sensors can be changed for dynamic vision sensors [15].

In this paper outside-in active marker based motion capture system for indoor localization of mobile robots is described. The paper presents the system and landmark design, the algorithm of image processing and the results of the testing.

II. SYSTEM DESIGN

The system for indoor mobile robot localization consists of three cameras, active LED landmark on the top of the robot and central computer, as shown in Figure 1.

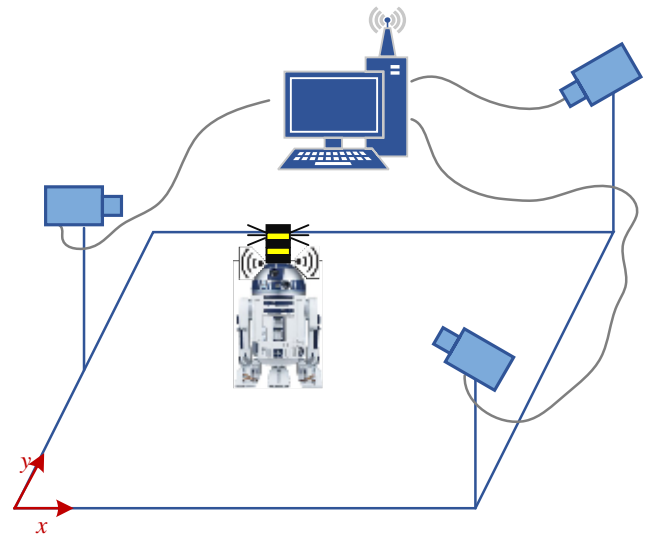

Figure 1. Design of the localization system.

The cameras are located on three pre-determined positions so each point on the rectangular playground is covered by at least one camera. Two cameras are placed in adjacent corners, while the third is placed on the middle of the opposite side, so that cameras and beacon share the same height. All of them are continuously capturing and communicating with the main computer by USB connection. The active LED landmark is placed on the robot and the cameras around are tracking its position. The LEDs are turned on and off when the main computer sends signal through wireless RF module. In addition to controlling the active LED landmark, the main computer acquires the images in certain moments from the cameras, works on image processing and calculates the position of the landmark in real coordinates. When the

position is calculated, the main computer is sending it as a message to the beacon, that is forwarding the message to the robot. From robot's point of view, the whole localization system is one periphery which is notifying robot about its current position.

III. MATERIALS AND METHODS

A. Image acquisition

The system contains three cameras, as shown in Figure 1. All cameras are Logitech HD Webcam C270. Angle of view of these cameras is 60° (48° horizontal field of view), resolution is 1280x720, focal length 4 mm, USB 2.0 connection, frame rate 30 fps. Standard drivers are used. Every part of the playground can be seen by at least one camera, while some parts are covered by two or three of them (Figure 2). Cameras are connected to the main computer by standard USB 2.0 interface.

The main program on the computer has two threads that are operating simultaneously. The first thread is made for the main algorithm execution, while the second thread works on image acquisition. Every frame captured by each camera is stored in a local buffer, and accessed by the first thread. The both threads work on the same resource, so mutex for external synchronization is implemented.

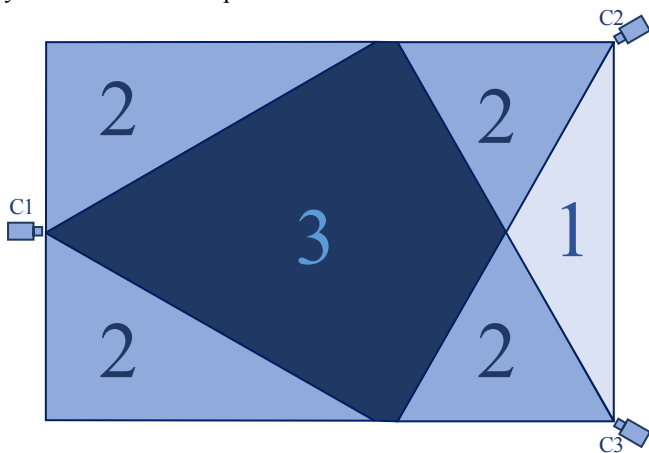

Figure 2. Playground coverage. The lightest part is covered by one, darker by two, darkest by three cameras.

B. Image processing

The image processing algorithm, used for localization, requires two input images. The first image is taken while LEDs on the landmark are on, while the second one is the photo of the same scenario after the LEDs are turned off. The operating image is the result of subtraction of the frames. If there is no movement on the scene between these two frames are captured, the operating image should contain only the landmark. In order to reduce the noise, the image is filtered by LF Gaussian filter. In the next step, the three RGB channels of the image are converted in one, gray scale image. After this, value of each pixel is compared to the threshold. If it exceeds the threshold the value becomes 255, and if it does not, the value becomes 0.

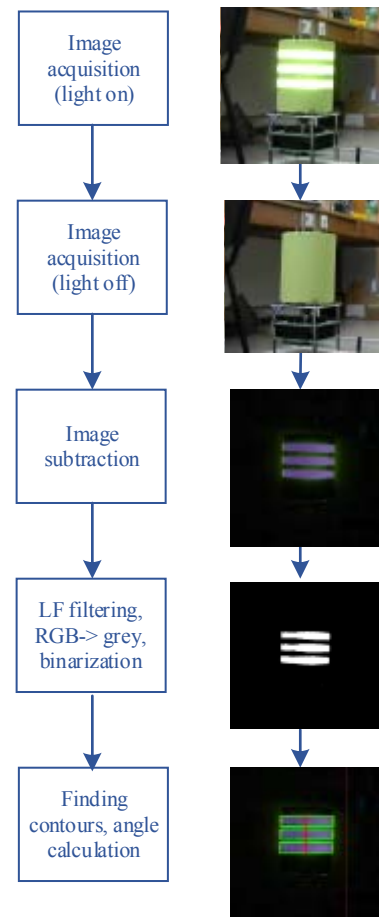

Figure 3. Image processing algorithm.

In this newly-constructed, binary image, background is black, while the beacon is the only white part. Position of the landmark is found by a function that is searching for closed contours. This function takes a binary image and returns a list of contours found in it. The algorithm goes through each pixel of the image and saves the coordinates of the outer pixels in every white pattern. When all the contours are found, they are rounded with the smallest rectangles that can cover them. Three rectangles that are parallel and of similar size are declared as the landmark.

In order to determine the real world 3D coordinates of the landmark it is crucial to calculate the distance between the landmark and the camera. When position of the landmark is known on the image, it can be calculated in the referent system of the camera. This can be done due to knowing the exact size of the landmark, but it appears that this method is not precise. The advantage of this approach is that the global position of object can be found if it is seen by only one camera. The second approach is calculating the angle between the object and the main axes of the camera (dashed lines on Figure 4). This approach gives much better results, because in this case the error is 0.0375°. Even though the second approach is more accurate, it cannot be used in every situation. When the object is covered by one camera there wouldn't be enough information to calculate its position. This system uses the

second approach when the object is detected by two or more cameras, whereas it uses the first one when the landmark is placed in the field that is covered by only one camera.

C. Triangulation

Triangulation is the process of determining the location of a point by measuring angles to it from known points. When the landmark is seen by a camera, the angle between it and the camera is calculated. Taking into account that camera is in the fixed position, finding out the angle gives enough information to calculate the line on which the object is located. If the object is detected by two cameras, its position is calculated as the intersection of the lines. If the object is detected by one camera its position is calculated by using thin lens formula. Finally, if all the cameras detect the landmark its position can be calculated on various ways. In theory, all the lines will intersect in one point. However, this is not the case in real application.

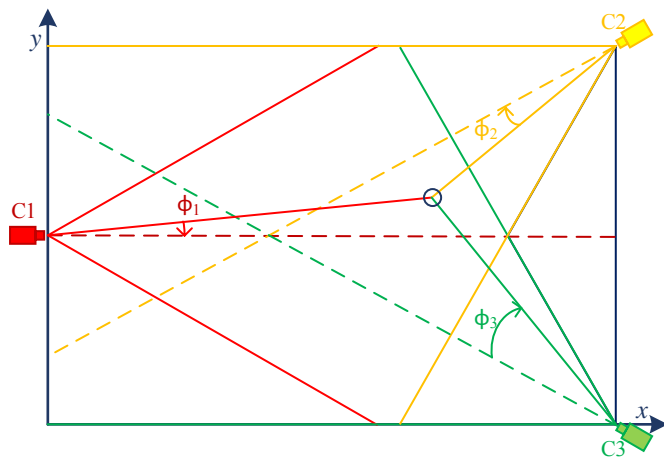

Figure 4. Triangulation.

D. Software design

Algorithm for localization, based on the results of image processing, is written in C++ in *Microsoft Visual Studio 2012* with *OpenCV* [16] and *Boost* libraries. UML diagram of the software is presented on Figure 5.

The software is divided into classes according to functionality. The main class is called *Localization* and it contains methods for image acquisition, image processing and triangulation. Attributes of this class are frames from the cameras, current position of the robot, distance and angle between the robot and each camera.

Fundamental principles of serial communication are implemented in the class *Serial*. Methods of this class allow serial data transfer (reading and writing) between the central computer and the beacon or referent system. Apart from this, more sophisticated methods that include predefined communication protocol are included in classes *BeaconCommunication* and *SystemCommunication*, derived from the class *Communication*.

In case that communication port is not opened or that the computer does not see all the cameras are caught by the class

ProgramException, that has two derived classes, depending on the type of exception.

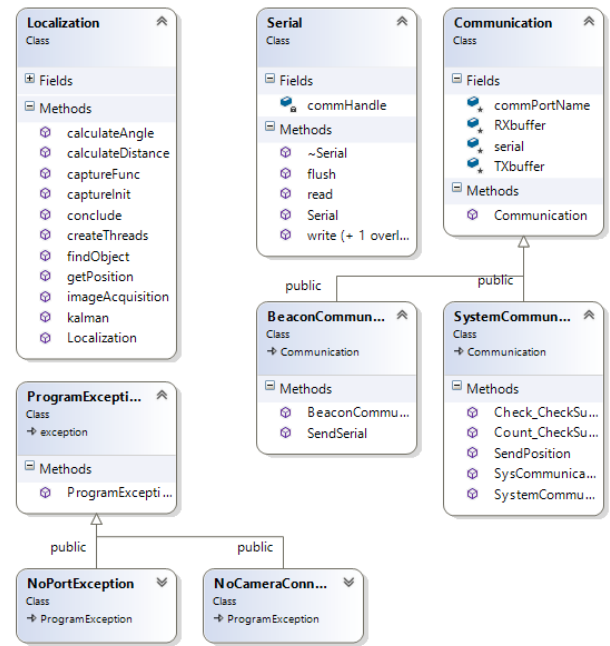

Figure 5. UML diagram.

E. Active beacons

The active beacon is constructed so the landmark has the same shape in each camera's view. For that purpose, cylinder shape is most appropriate. The beacon is made of two parts: the top part that is the landmark, and the bottom part that contains electronics required for independent active LED landmark functioning.

Landmark is made of two cylinders, the inner and the outer. The inner cylinder is covered by LEDs and its purpose is to emit light. Outer cylinder is made of light blocking and diffusing rings that are alternately stacked one on another. A green paper is wrapped around the beacon so the object looks completely green when LEDs are off and white when LEDs are on.

The bottom part of the beacon is responsible for communications between robot and landmark and the main computer and landmark and for control of the LEDs (Figure 6). The core of the beacon is microcontroller, *ATmega 162*, that is programmed to manage the LEDs and communicate. The beacon has its own power source, four batteries, each 1.2 V. The voltage is stabilized to 3.3 V by *BA033CCOWFP* voltage stabilizer. The beacon communicates with the main computer by wireless communication through RF *XBEE* module, that is connected to the microcontroller by UART interface. The voltage for the LEDs is made of the voltage source and DC/DC converter that uses *FAN5331* and increases voltage to 12 V. One output pin of the microcontroller is used to control DC/DC converter. When the calculation of the position is over, the main computer sends message to the beacon telling it its current coordinates. The message is

forwarded to the robot by wired RS485 bus. Second UART port of the microcontroller is connected to the bus driver, MAX1487, and on its output is the bus.

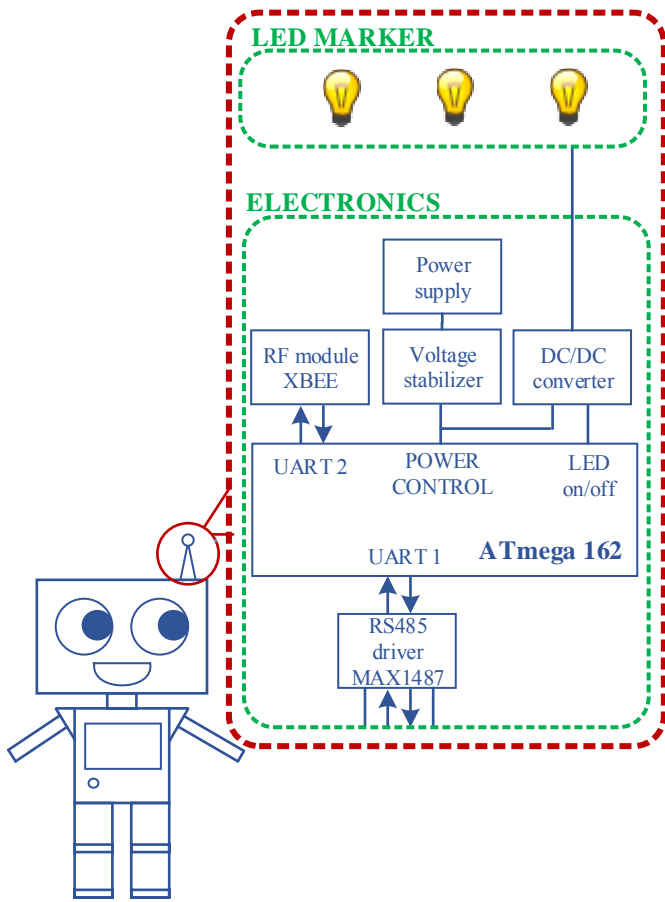
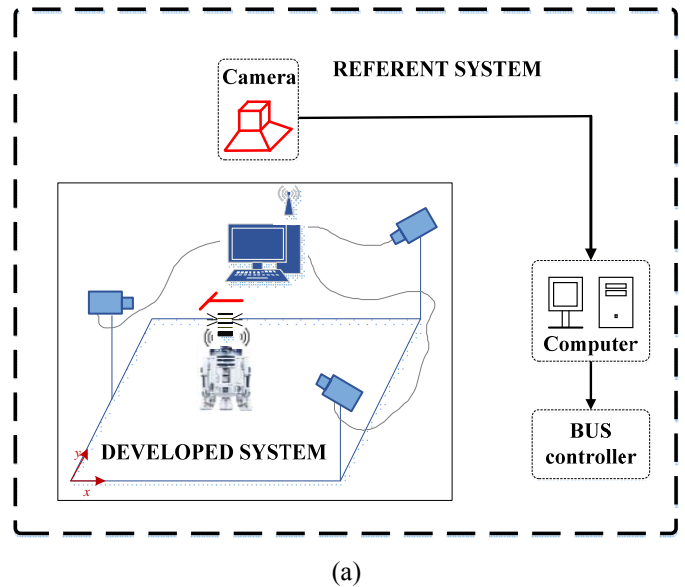

Figure 6. Structure of the active LED beacon.

IV. EVALUATION AND TESTING

The proof of concept and the performance of the system is estimated comparing it to earlier developed system for indoor localization [17]. The referent system is composed out of a computer which executes the image processing software, a camera which delivers the images to the computer, an active landmark in form of letter “T” positioned on the top of the mobile robot, a reference frame formed by four active markers and a communication interface which enables usage of the system as standalone component. The camera is placed above the center of the terrain so that it can capture the whole field together with the reference frame.

The outline sketch of both systems integrated in the same testing environment is presented in Figure 7a, while the photo of the terrain with one robot is presented in Figure 7b.



(a)

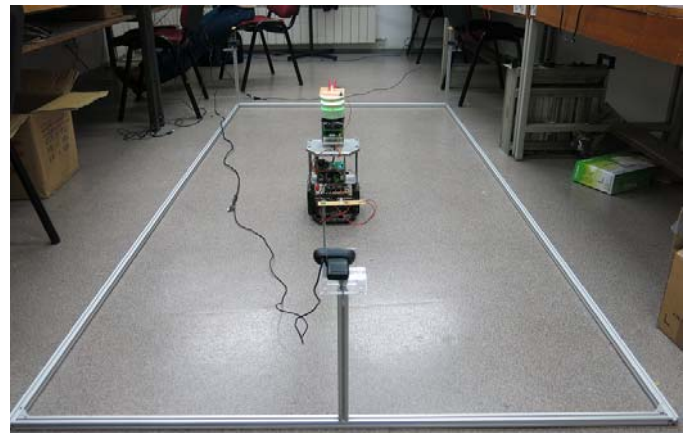

(b)

Figure 7. a) Testing setup. The integration of the referent and the developed system during testing. b) Photo of the terrain with one mobile robot.

One cycle for position calculation lasts 249 ms, which is equivalent to four positions per second. Two types of testing are done: static and dynamic.

Static testing covers setting the robot in several predefined positions on the field while measuring the outputs from the developed system. The results of static testing are shown on Figure 8. The results of the testing are presented in Table I.

TABLE I. RESULTS OF STATIC MEASUREMENT.

Type of Error				
RMSE [mm]	Mean [mm]	Median [mm]	Min [mm]	Max [mm]
33.66	30.18	23.54	12.04	62.43

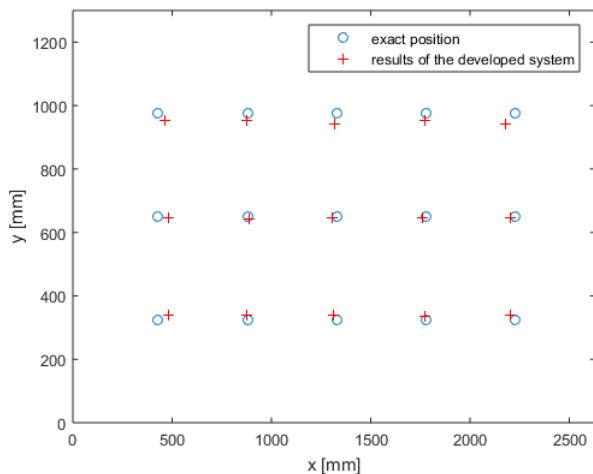

Figure 8. Results of static testing: blue circles denote actual positions measured by the referent localization system and red crosses represent the output of the developed system.

The second part of testing is done through the dynamic experiment. The robot was driven automatically, on pre-determined path, while both developed and referent system were collecting the results. The results of the experiment are shown on Figure 9. Root mean square error measured during the test is 36.47 mm.

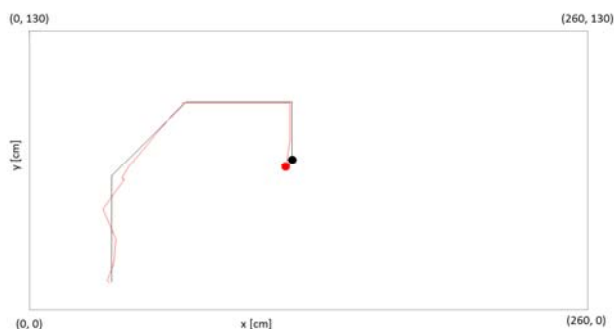

Figure 9. Results of the testing: black line denotes actual position measured by the referent localization system and red line represents the output of the developed system.

V. CONCLUSION

The machine vision technology was successfully used in implementation of the indoor localization system of mobile robots. The system is designed to be used with cheap and affordable cameras. The main problem with robust identification of visible beacons lies in interferences with similar objects which can be found in natural environment. This problem is overpowered by using robust background suppression technique built under usage of active beacons. This also lowered the computational complexity of the image processing algorithm resulting in the ability of real-time application.

The main disadvantage of this system comparing to other vision based motion capture systems is its natural limitation to strict planar movements. Of course, this concept could be used to build three dimensional motion capture system by adding more cameras in non-planar manner.

The main advantage of the system is its low price and low complexity of used image processing algorithms.

Future work should cover improvements in image processing algorithm and usage of Kalman filter.

ACKNOWLEDGMENT

This work was supported by the Serbian Ministry of Education, Science and Technological Development under Grant No. TR32043.

REFERENCES

- [1] S. Thrun, D. Fox, W. Burgard, and F. Dellaert, "Robust monte-carlo localization for mobile robots," *Artificial Intelligence*, vol. 128, no. 1-2, pp. 99–141, 2000.
- [2] Borenstein, Johann, and Liqiang Feng, "Measurement and correction of systematic odometry errors in mobile robots," in *Robotics and Automation, IEEE Transactions on*, vol. 12, no. 6 (1996): 869-880.
- [3] S. Thrun, D. Fox, W. Burgard, and F. Dellaert, "Robust monte-carlo localization for mobile robots," in *Artificial Intelligence*, vol. 128, no. 1-2, pp. 99–141, 2000.
- [4] Tsai, Ching-Chih, "A localization system of a mobile robot by fusing dead-reckoning and ultrasonic measurements," in *Instrumentation and Measurement Technology Conference, 1998. IMTC/98. Conference Proceedings. IEEE*, vol. 1, pp. 144-149. IEEE, 1998.
- [5] C. Chang, C. Siagian, L. Itti, "Mobile Robot Vision Navigation & Localization Using Gist and Saliency," in *IEEE/RSJ International Conference on Intelligent Robots and Systems*, pages 4147-4154, October 2010.
- [6] Panzneri, Stefano, Federica Pascucci, and Giovanni Ulivi "An outdoor navigation system using GPS and inertial platform," *Mechatronics, IEEE/ASME Transactions on*, vol. 7, no. 2 (2002): 134-142.
- [7] Navarro-Serment, Luis E., Christiaan JJ Paredis, and Pradeep K. Khosla, "A beacon system for the localization of distributed robotic teams," in *Proceedings of the International Conference on Field and Service Robotics*, vol. 6. 1999.
- [8] Blösch, Michael, Stephan Weiss, Davide Scaramuzza, and Roland Siegwart, "Vision based MAV navigation in unknown and unstructured environments," in *Robotics and automation (ICRA), 2010 IEEE international conference on*, pp. 21-28. IEEE, 2010.
- [9] M. Cummins and P. Newman, "Fab-map: Probabilistic localization and mapping in the space of appearance," *Int. J. Rob. Res.*, vol. 27, no. 6, pp. 647–665, 2008.
- [10] A. Pronobis, B. Caputo, P. Jensfelt, and H. Christensen, "A discriminative approach to robust visual place recognition," in *IROS*, 2006.
- [11] A. Ramisa, A. Tapus, R. L. de Mantaras, and R. Toledo, "Mobile robot localization using panoramic vision and combination of local feature region detectors," in *ICRA, Pasadena, CA, May 2008*, pp. 538–543.
- [12] C. Siagian and L. Itti, "Biologically inspired mobile robot vision localization," in *IEEE Transactions on Robotics*, vol. 25, no. 4, pp. 861– 873, July 2009.
- [13] <http://www.cs.cmu.edu/~yaser/Lecture-3-MarkerBasedMocap.pdf>.
- [14] D. Vlastic, R. Adelsberger, G. Vannucci, J. Barnwell, M. Gross, W. Matusik, J. Popovic, "Practical Motion Capture in Everyday Surroundings," in *ACM Transactions on Graphics (TOG)*, vol. 26 no. 3, July 2007.

- [15] A. Censi, J. Strubel, C. Brandli, I. Delbruck, D. Scaramuzza, "Low-latency localization by Active LED Markers tracking using Dynamic Vision Sensor," in IEEE/RSJ Intl. Sont. on Intelligent Robots and Systems.
- [16] <http://opencv.org>.
- [17] Nemanja V. Janković, Svetislav V. Ćirić, Nenad S. Jovičić, "System for Indoor Localization of Mobile Robots by Using Machine Vision", In Telecommunications Forum (TELFOR), 2015 23th. IEEE.